

BMW Wallbox Instructions for use

Contents

1 Information	44
2 Overview	49
3 Requirements	50
4 Installation	52
5 Connect the terminals	56
6 DIP switch settings	57
7 Local load management	61
8 Commissioning	65
9 Operation	66
10 LED display	70
11 Troubleshooting	71
12 Technical data	72
13 Waste disposal	75

EN

1 Information

1.1 Symbols used



Denotes instructions that draw your attention to dangers.



Denotes instructions that draw your attention to special features.

◀ Denotes the end of the instruction or warning text.

1.2 Safety information



- Read the safety information carefully and familiarise yourself with the device before you attempt to install, operate or service it.
- Danger from electricity. The BMW Wallbox must be installed, commissioned and serviced by appropriately trained, qualified and authorised electricians ⁽¹⁾, who bear full responsibility for complying with the current standards and installation regulations.
- Please note that vehicles or national regulations may require additional overvoltage protection. Please refer to your national connection and installation standards.
- Check that all screw and clamp connections are secure before commissioning the device. The terminal block must never be left open unattended. Fit the cover on the terminal block if you leave the BMW Wallbox unattended during the installation work.
- Do not make any unauthorised changes or modifications to the BMW Wallbox.
- You must not carry out any repair work to the BMW Wallbox. Such work may only be carried out by the manufacturer or a trained expert (for example replacing the BMW Wallbox).
- Do not remove any identifiers such as safety symbols, warnings, model plates, labels or cable markings.
- The BMW Wallbox does not have a main switch. The RCCB and circuit breaker on the building installation are used as the mains isolator.

⁽¹⁾ People who, as a result of their training, skills and experience and their knowledge of the relevant standards can assess the work and identify possible dangers. ◀



- Do not pull the vehicle connector plug by the cable, and instead use the handle on the vehicle connector plug to remove it from the vehicle socket.
- Ensure that the vehicle connector plug is not mechanically damaged (kinked, jammed, or run over) and that the contact area does not come into contact with heat sources, dirt or water.
- Do not touch the contacts on the vehicle connector plug.
- Always carry out an inspection for signs of damage before the charging cycle. Pay particular attention to dirt and moisture on the vehicle connector plug, cuts in the cable or chafing areas on the insulation. Ensure that the cable output is firmly secured to the BMW Wallbox.
- Do not clean the BMW Wallbox with a water jet (hosepipe, pressure washer, etc.).
- Ensure that the BMW Wallbox is not damaged by being handled incorrectly.
- Do not open the cover on the terminal block if the BMW Wallbox is installed outdoors and it is raining or snowing.
- Danger of breaking the plastic housing (protection class IK09).
- Do not use countersunk screws to secure the device.
- Only tighten the screws to the specified torque.
- The installation surface must be completely level (max. 1 mm difference between the support and fastening points). Do not bend the housing ◀

Information for trained personnel who may open the housing: Danger of damage. Electronic components may be destroyed if touched. Conduct an electrical discharge procedure before handling modules by touching a metallic, earthed object. If you fail to follow the safety information, there is a risk of death, injury and damage to the device. The manufacturer cannot accept any liability for resultant claims.

1.3 CE declaration of conformity

The CE declaration of conformity can be downloaded from the following link.

<https://www.bmw.com/supportwallboxgen3>

1.4 Declaration of conformity for electromagnetic compatibility: Federal Communications Commission Part 15

The BMW Wallbox complies with all the specifications from Part 15 of the Federal Communications Commission. Operating the BMW Wallbox is subject to the following conditions: (1) This device must not cause any harmful interference, and (2) This device must accept all received interference, including interference which may cause it to malfunction.

1.5 Information about Directive 2014/94/EU

You must comply with national regulations (for example the Charging Column Regulation in Germany) for implementing the EU Directive (2014/94/EU) relating to the mandatory technical specifications for sockets and vehicle couplings for charging electric or plug-in hybrid vehicles in areas accessible to the general public. This regulation concerns charging points on public property and for example car parks at business premises or for customers. Charging points in private car ports or on private garage entrances are not publicly accessible charging points in the sense of the regulation.

1.6 Intended use

The BMW Wallbox is a charging station for indoor and outdoor use for charging electric or plug-in hybrid vehicles. Do not connect any other devices to it, for example electric tools. The BMW Wallbox is designed for installation on a wall or column. You must comply with the relevant national regulations for installing and connecting the BMW Wallbox. The intended use of the device in all cases includes compliance with the ambient conditions for which this device was developed. The BMW Wallbox was developed, manufactured, tested and documented on the basis of the relevant safety standards. If you follow the instructions and safety information for its intended use, the product will not pose any danger of material damage or to people's health. This device must be earthed. In the event of an error, the earth connection will reduce the risk of an electric shock. Follow the instructions in this manual to the letter. Otherwise, sources of danger may be created or safety equipment may be rendered inoperable. In addition to the safety information in this manual, you must also comply with the safety and accident prevention regulations for the specific device.

1.7 About this manual

This manual and the functions described in it are valid for devices of the following type: BMW Wallbox:

- 61 90 5 A1E 1B1
- 61 90 5 A1E 1B2
- 61 90 5 A1E 1B3
- 61 90 5 A1E 1B4
- 61 90 5 A1E 1B5

The illustrations and explanations contained in this manual refer to a typical version of the device. Your version of the device may differ from this.

1.8 Package

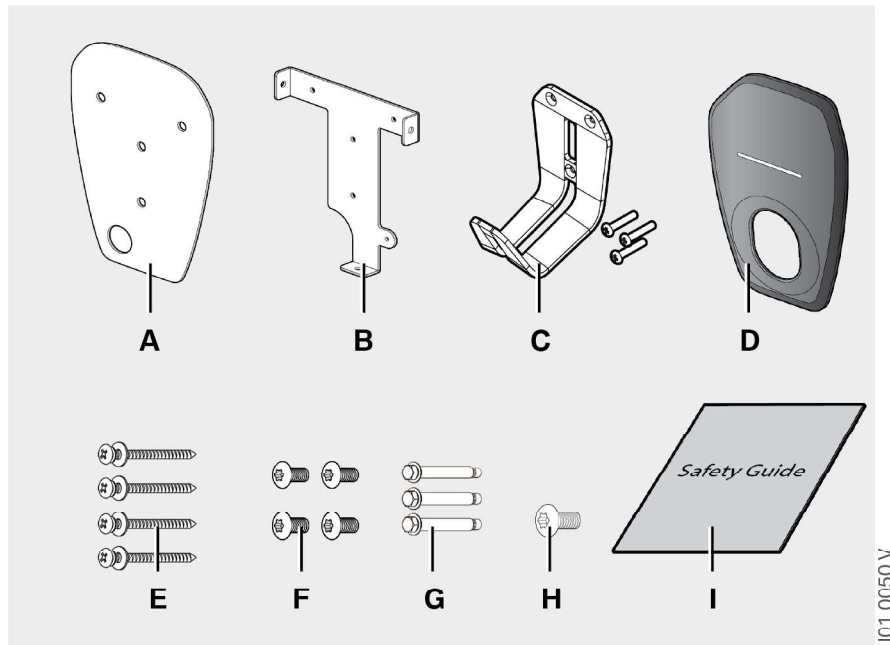

- A Mounting template
- B Mounting bracket
- C Cable holder
- D Housing cover
- E Wood screws No. 8 (4 x)
- F Torx T30 fastening screws (4 x)
- G Countersunk screws 1/4" (3 x)
- H Torx T20 security screw
- I Safety guide

EN

1.9 Warranty

Further information about the warranty terms and conditions is available from BMW Service. However, the following cases are not covered by the warranty.



- Defects or damage caused by installation work not carried out as described in this document.
- Defects or damage caused by using the product for purposes other than those described in this document.
- Costs and damage caused by repair work not carried out by an electrician authorised by a BMW sales outlet or an authorised service workshop. ◀

2 Overview

2.1 Displays and controls

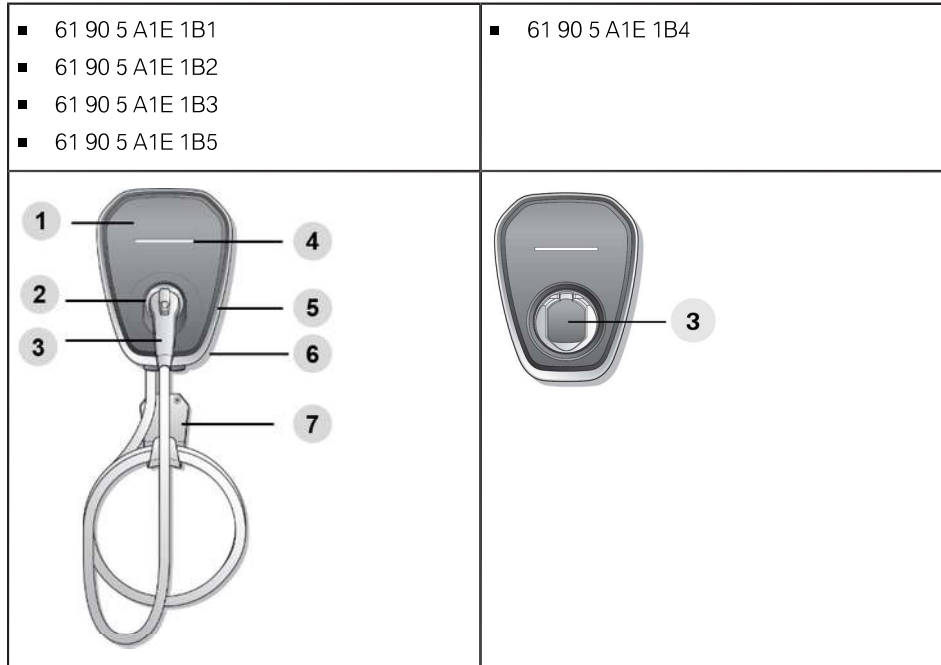

1. Housing cover
2. Vehicle plug connector holder
3. Vehicle plug connector (L)/Charging socket with shutter (R)
4. LED display
5. Terminal block cover
6. Mounting bracket
7. Cable holder

3 Requirements

3.1 General criteria for site selection

The BMW Wallbox is designed for indoor and outdoor use. Therefore, it must be ensured that the site you select complies with the installation conditions and provides suitable protection for the device.

- Ensure that you comply with local regulations for electrical installations, fire safety and accident prevention as well as keeping local rescue and escape routes clear.
- Do not install the BMW Wallbox at locations:
 - Which are used as escape and rescue routes,
 - Which are inside zones where there is an explosion risk,
 - At which the BMW Wallbox is exposed to ammonia or ammonia gases,
 - At which the BMW Wallbox may be damaged by falling objects,
 - At which the BMW Wallbox is on a footpath used by people who may trip over the connected vehicle connector plug,
 - At which the BMW Wallbox may be struck by a water jet,
 - At which the installation surface does not have the requisite capacity to withstand the mechanical stresses.
- If possible, install the BMW Wallbox so that it is not exposed to direct sunlight to prevent excessive temperatures on components of the BMW Wallbox reducing the charging current or interrupting the charging cycle.
- Ensure that the ambient temperatures comply with the specifications, see section entitled "Technical Data".
- Ensure that you comply with the national and international installation standards and regulations.

3.2 Specifications for the electrical connection

When it is delivered, the BMW Wallbox is set to a maximum charging current of 6 A. Ensure that you set the maximum current for the installed circuit breaker using the DIP switch (see section entitled "Power settings").

3.3 Choice of RCCB

The connection cable must be wired into the existing building installation and comply with the national statutory regulations. For versions

- 61 90 5 A1E 1B1
- 61 90 5 A1E 1B4

the following considerations must be made:

- Every BMW Wallbox must be connected using its own residual-current-operated circuit breaker (RCCB). No other circuits may be connected to this RCCB.
- RCCB at least type A (30 mA trip current).
- Additional measures have been taken in the device to protect it from a direct current (DC) error (> 6 mA DC).
- These measures satisfy the requirements of IEC 62955. This means that there is no general necessity to use a residual current device (RCD) type B, unless one is explicitly required by the applicable installation regulations.

3.4 Choice of circuit breaker

When selecting the circuit breaker, you must also take into account the increased ambient temperatures in the control cabinet. In certain circumstances, this may require the charging current to be reduced to increase the system's availability. Set the rated current to suit the required charging capacity, the available connecting rating and the details on the model plate.

An RCD type B (40 A min. and 400 V min.) must be used for the following versions:

- 61 90 5 A1E 1B1
- 61 90 5 A1E 1B2
- 61 90 5 A1E 1B4

An RCD type B (50 A min. and 250 V min.) must be used for the following versions:

- 61 90 5 A1E 1B3
- 61 90 5 A1E 1B5

3.5 Choice of connection cable

When selecting the connection cable, take into account the possible reduction factors and increased ambient temperatures in the BMW Wallbox's internal connection zone, see temperature details for the connection terminals. In certain circumstances, this may require the cable cross-section to be increased and the temperature resistance of the connection cable to be adjusted.

3.6 Mains isolator

The BMW Wallbox does not have a main switch. The RCCB and circuit breaker on the building installation are used as the mains isolator.

4 Installation

4.1 Installation requirements

- Comply with the local installation regulations.
- Acclimatisation: If there is a temperature difference of more than 15 °C between transport and the selected installation site, the BMW Wallbox must be allowed to acclimatise unopened for at least two hours. Opening the BMW Wallbox immediately may result in condensation forming in its interior and causing damage when the device is switched on. In certain circumstances, damage caused by condensation formation may also not appear until after the installation. Ideally, the BMW Wallbox should be stored for several hours at the installation site before installation. If this is not possible, the BMW Wallbox should not be stored in low temperatures (< 5 °C) overnight outdoors or in a vehicle.

4.2 List of tools

- Measuring tool and pen
- Drill
- Torx T30 screwdriver
- Torx T20 security screwdriver
- Cross-head screwdriver No. 2
- Crimping tools

4.3 Recommended installation site

When selecting the installation site, consider access from the charging socket to the vehicle and the direction in which the vehicle is normally parked.

4.4 Required spacing

Refer to the illustration below for choosing the installation site.

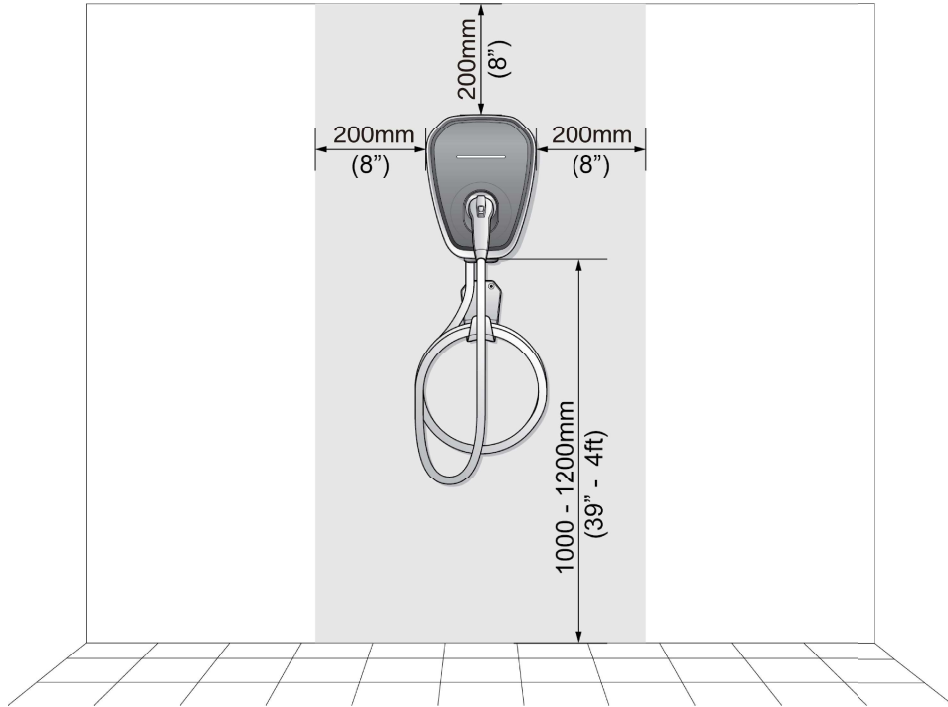

EN

4.5 Install the BMW Wallbox

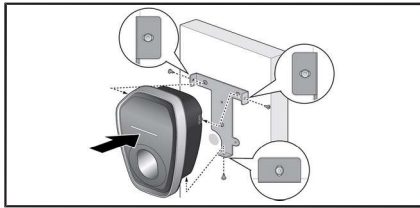
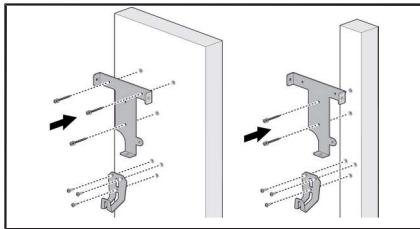
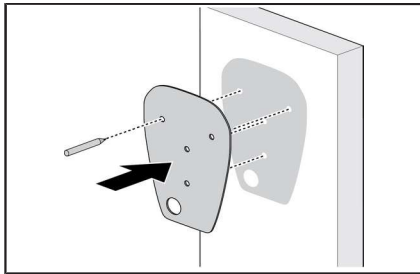

1. The product is a stationary, wall-mounted device. It contains a mounting template to mark the screw positions for the mounting bracket and the optional cable holder.

2. Secure the mounting bracket to the wall.

We recommend the following screw types:

- Masonry walls:

Countersunk screws 1/4". Tightening torque:
8,8 Nm (78 lb in)

- Drywalls supported by wooden posts:
Wood screws No. 8, at least 2" in length.

Tightening torque:

3 Nm (26 lb in)

3. Align the screw holes using the mounting bracket and product.

4. Install and secure the product on the mounting bracket using the Torx T30 screws supplied.

Tightening torque: 1.5 Nm (13 lb in)

4.6 Remove the covers

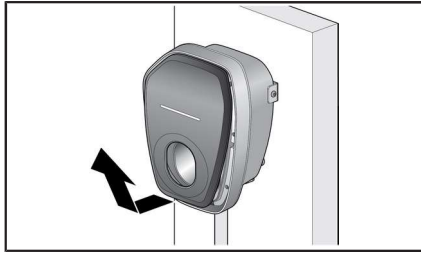

5. Remove the housing cover.

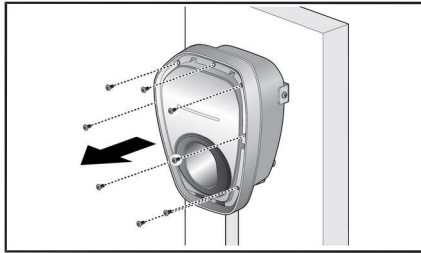

6. Use a T20 screwdriver to remove the screws which secure the terminal block cover.

Tightening torque: 1.4 Nm (12 lb in)

7. Remove the terminal block cover.

4.7 Secure the anti-theft screw

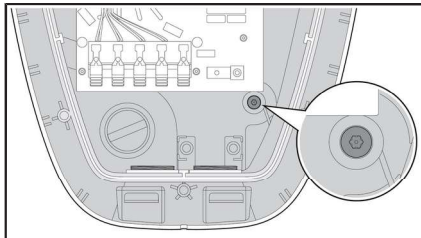

8. Secure the anti-theft screw.

5 Connect the terminals

Use a suitable cable with wire-end ferrules.

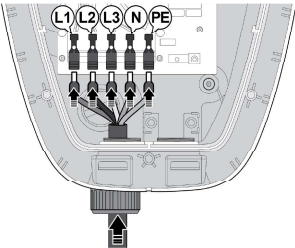
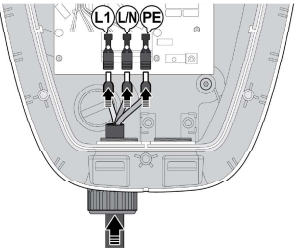
<ul style="list-style-type: none"> ■ 61 90 5 A1E 1B1 ■ 61 90 5 A1E 1B2 ■ 61 90 5 A1E 1B4 	<ul style="list-style-type: none"> ■ 61 90 5 A1E 1B3 ■ 61 90 5 A1E 1B5 	
 <p>Note: It is also possible to use a single-phase connection for the BMW Wallbox. To do so, connect terminals L1, N and PE</p>		<p>Connect each terminal to the correct connection on the input terminal strip. Then secure the terminal for the input cable correctly.</p> <p>Note: Select a suitable cable to comply with all current local, state and national regulations and standards for electrical systems. Ensure that the circuit breaker is switched off before installation.</p>

5.1 Input X1 (optional)

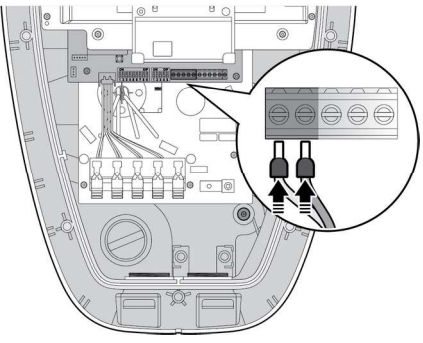
	<p>Connect the cable to connection X1.</p> <p>The enabling input is designed for use with a floating contact. The enabling input allows the Wallbox to be controlled by external components.</p>
<p>Note: The safe isolation of dangerous voltages must be guaranteed.</p>	

6 DIP switch settings

6.1 Setting the earth system

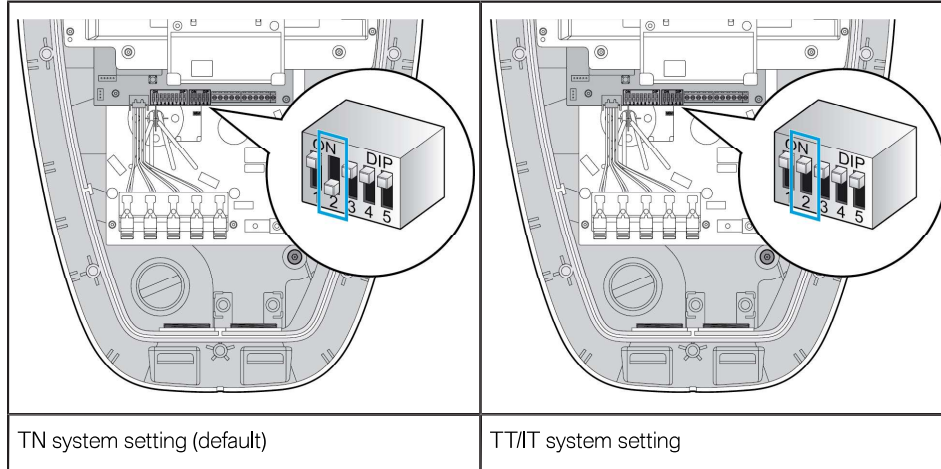

6.2 Power settings

When it is delivered, the BMW Wallbox is set to a maximum charging current of 6 A.

The following settings apply to these versions:

- 61 90 5 A1E 1B1
- 61 90 5 A1E 1B2
- 61 90 5 A1E 1B4

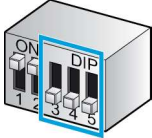
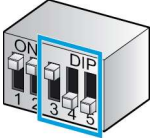
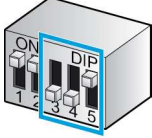
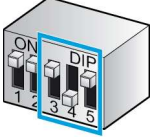
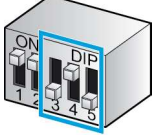
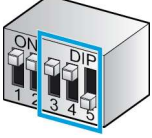
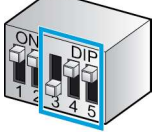
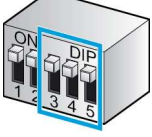
Configuration	Max. rated current	Configuration	Max. rated current
000 	0 A	100 	16 A
001 	6 A	101 	20 A
010 	10 A	110 	24 A
011 	12 A	111 	32 A

The following settings apply to these versions:

- 61 90 5 A1E 1B3
- 61 90 5 A1E 1B5

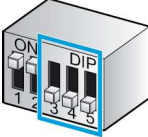
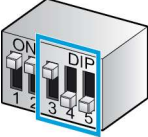
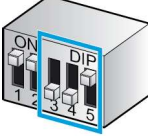
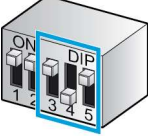
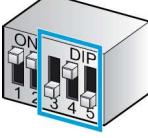
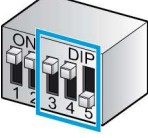
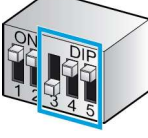
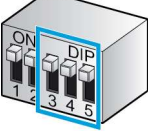
Configuration	Max. rated current	Configuration	Max. rated current
000 	0 A	100 	20 A
001 	6 A	101 	24 A
010 	12 A	110 	32 A
011 	16 A	111 	40 A



6.3 Authorisation settings

The BMW Wallbox is set at the factory so that all charging cycles must be authorised using an app. If you do not wish to have to authorise every charging cycle and enable free access to the BMW Wallbox at all times, the DIP switch must be set to “OFF” (see figure on the right)

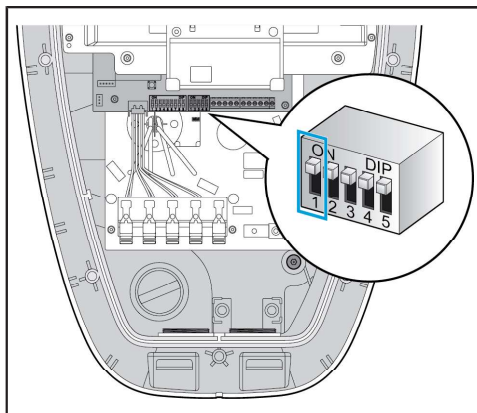
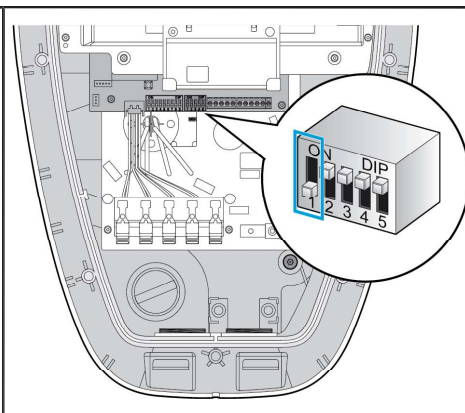
	
<p>Default setting: Access to the BMW Wallbox and charging cycle authorisation by app only.</p> <p>Note: On the date of the sales launch, the myBMW app will only be available in China. Its launch in other countries is currently being planned.</p>	<p>Free access to the BMW Wallbox without authorisation by app before each charging cycle.</p>

7 Local load management

7.1 Connection of external energy meters

Connect the external energy meter to enable you to monitor your home connection.

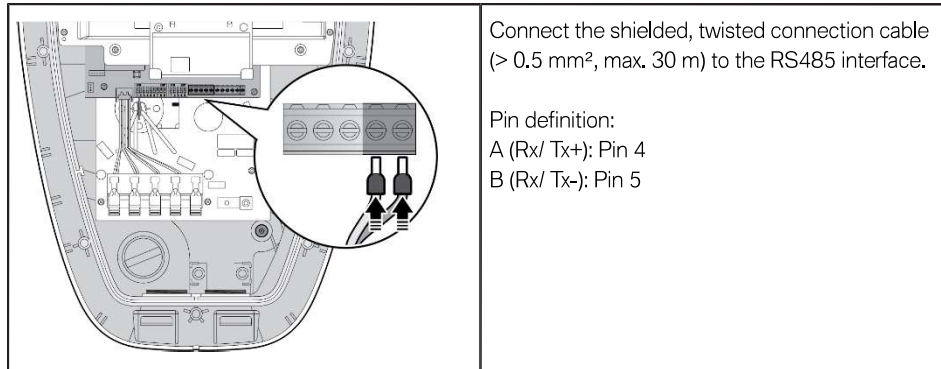

EN

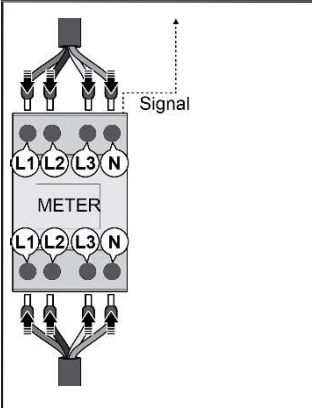
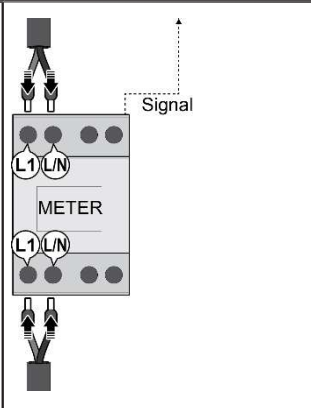
<ul style="list-style-type: none"> ▪ 61 90 5 A1E 1B1 ▪ 61 90 5 A1E 1B2 ▪ 61 90 5 A1E 1B4 	<ul style="list-style-type: none"> ▪ 61 90 5 A1E 1B3 ▪ 61 90 5 A1E 1B5 	
		<p>Connect the meter to the power supply. Refer to the specific instructions supplied in the meter's operating instructions.</p>

7.2 Phase assignment

The phase assignment between the Wallbox and household connection can be set using DIP switches.

The phase assignment between the Wallbox and household connection/meter can be set using DIP switches 2 and 3

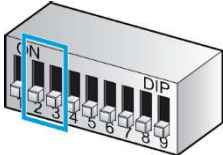
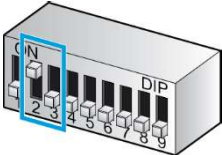
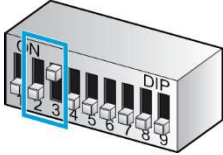
DIP switch setting	Phase assignment household connection/meter -> Wallbox	Configuration	Phase assignment household connection/meter -> Wallbox
00 	L1 -> L1 L2 -> L2 L3 -> L3	10 	L3 -> L1 L1 -> L2 L2 -> L3
01 	L2 -> L1 L3 -> L2 L1 -> L3		





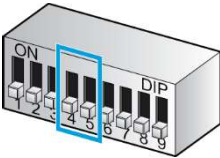
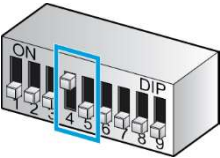
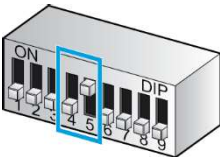
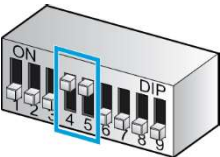





7.3 Function to monitor asymmetric loads

The maximum current value for an asymmetric load can be defined using DIP switches 4 and 5.

DIP switch setting	Maximum current	DIP switch setting	Maximum current
00 	Function to monitor asymmetric loads disabled (factory setting)	10 	16A
01 	10A	11 	20A

7.4 Household connection monitor

The limit value for the size of the household connection can be defined using DIP switches 6 to 9.

DIP switch setting	Maximum current	DIP switch setting	Maximum current
0000 	Local load management disabled (factory setting)	0110 	80A
0001 	20A	0111 	100A
0010 	25A	1000 	125A
0011 	35A	1001 	150A
0100 	50A	1010 	200A
0101 	63A		

8 Commissioning

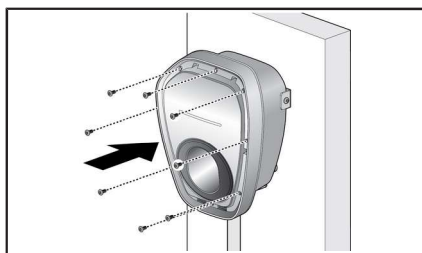

Install the terminal block cover
Tightening torque: 1.0 Nm (8.7 lb in)

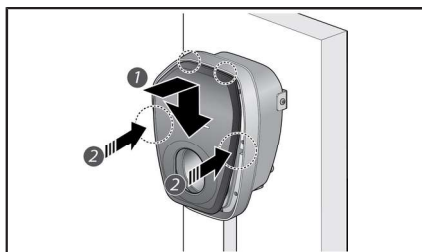

Install and lock the housing cover.

EN

9 Operation

The BMW Wallbox is supplied as standard with its access control by app enabled. Please change the DIP switch setting if you do not wish to use access control by app. Further information is available in section "5.3 Authorisation settings".

Note: On the date of the sales launch, the app will only be available in China. Its launch in other countries is currently being planned.

9.1 Starting the charging cycle with access control enabled

1. Connect the vehicle connection plug to the vehicle charging socket.
2. Use the app to authorise and start the charging cycle.

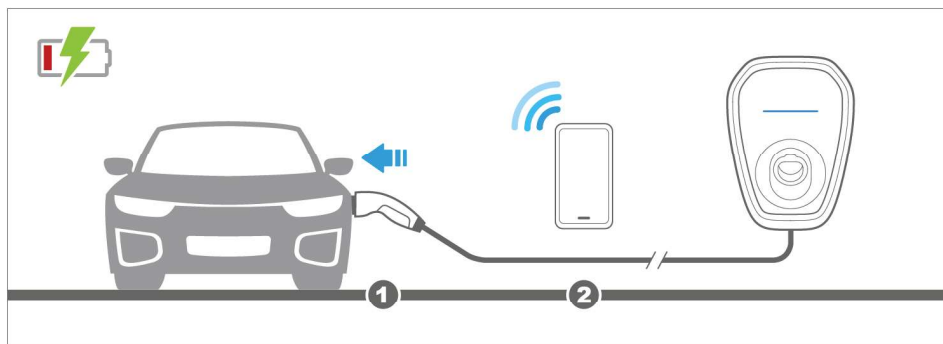

9.2 Stopping the charging cycle with access control enabled

1. Stop the charging cycle on the vehicle or using the app.
2. Disconnect the vehicle connection plug from the vehicle charging socket.
3. Place the vehicle connection plug back into the cable holder on the BMW Wallbox.

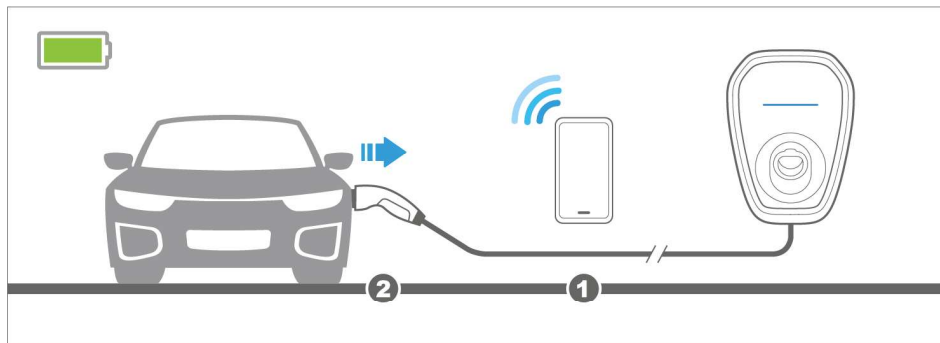

Note: Further information about ending the charging cycle is available in your vehicle owner's manual.

9.3 Starting the charging cycle with access control disabled

1. Connect the vehicle connection plug to the vehicle charging socket.
2. The vehicle will start the charging cycle automatically.

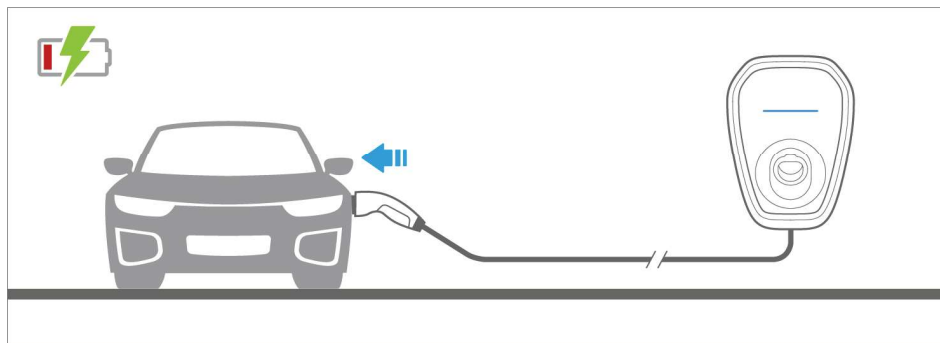

9.4 Stopping the charging cycle with access control disabled

1. Stop the charging cycle on the vehicle.
2. Disconnect the vehicle connection plug from the vehicle charging socket.
3. Place the vehicle connection plug back into the cable holder on the BMW Wallbox.

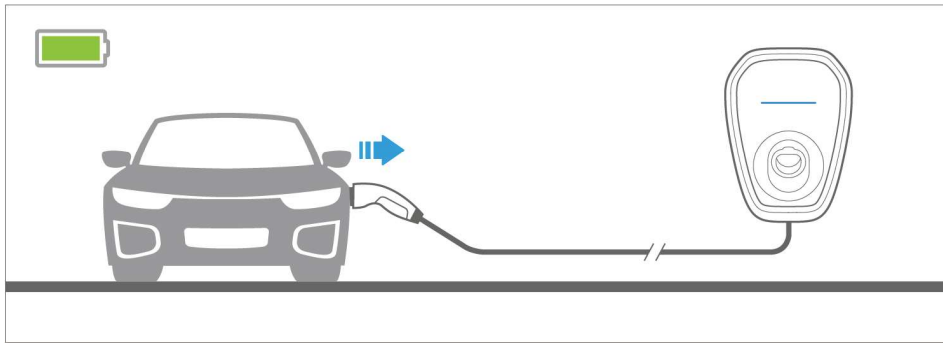

Note: Further information about ending the charging cycle is available in your vehicle owner's manual.

9.5 Wallbox service app

Your installer or BMW service partner can use the service and installation app to configure the device, download the charging history and diagnostic data, update the firmware and rectify errors. The DIP switch must be set correctly (see section 5 DIP switch settings) to use Wallbox service app. The app is available in all relevant app stores.

Functions:

- Charging history
- Installation guide
- Power settings
- Firmware update
- Diagnostic data
- Device restart

			
Wallbox service app iOS	Wallbox service app Android	Wallbox service app China	Wallbox service app Baidu

10 LED display

LED display	Status
No display	BMW Wallbox has no power supply.
Blue, from left to right continuously	BMW Wallbox initialisation process running.
Blue, steady	Vehicle is not connected. Wallbox is ready to charge. Ready status.
Blue, slow-moving	Vehicle charging.
Green, flashing (1x)	User login or authorisation successful.
Red, flashing (1x)	User login or authorisation failed.
Red, steady	Error.
Red, right-hand LED element	Bluetooth module failed.

11 Troubleshooting

Situation	Action
LED display has no power supply.	<ol style="list-style-type: none">1. No supply voltage – check the RCCB and circuit breaker and switch them on if necessary.2. Error on the BMW Wallbox – contact your local dealer.
The charging cycle is not started.	<ol style="list-style-type: none">1. The vehicle connection plug has not been inserted correctly – remove the vehicle connection plug and reconnect it.2. The vehicle has been programmed so that the charging cycle starts at a later time.3. The vehicle does not require any power – check the vehicle status.4. The app connection is not working correctly.
The vehicle connection plug cannot be disconnected.	The charging cycle has not been ended by the vehicle.
LED display lit in red.	<ol style="list-style-type: none">1. Switch off the supply voltage to the BMW Wallbox using the appropriate mains isolator.2. Disconnect the vehicle connecting plug and switch on the supply voltage again.3. If the situation persists, contact your local dealer.

12 Technical data

Part number	61 90 5 A1E 1B1	61 90 5 A1E 1B2	61 90 5 A1E 1B3	61 90 5 A1E 1B4	61 90 5 A1E 1B5
Vehicle connection plug	Type 2 plug	GB/T plug	SAE J1772 plug	Type 2 shutter	SAE J1772 plug
Input/Output values	220-240 V/ 380-415 V, 32 A, 50-60 Hz, three-phase 220-240 V, 32 A, 50-60 Hz, single-phase	220-240 V/ 380-415 V, 32 A, 50-60 Hz, three-phase 220-240 V, 32 A, 50-60 Hz, single-phase	240 V, 40 A, 60 Hz, single-phase	220-240 V/ 380-415 V, 32 A, 50-60 Hz, three-phase 220-240 V, 32 A, 50-60 Hz, single-phase	240 V, 40 A, 50-60 Hz, single-phase
Input wiring	L1, L2, L3, N, PE	L1, L2, L3, N, PE	L1, L2, PE	L1, L2, L3, N, PE	L1, N, PE
Earthing system	TT/ TN/IT				
Rated current (rated current can be adjusted using DIP switch)	0 A, 6 A, 10 A, 12 A, 16 A, 20 A, 24 A, 32 A	0 A, 6 A, 10 A, 12 A, 16 A, 20 A, 24 A, 32 A	0 A, 6 A, 12 A, 16 A, 20 A, 24 A, 32 A, 40 A	0 A, 6 A, 10 A, 12 A, 16 A, 20 A, 24 A, 32 A	0 A, 6 A, 12 A, 16 A, 20 A, 24 A, 32 A, 40 A
Cable length	5 m	5 m	25 ft	N/A	5 m
Cable feed	Surface-mounted	Surface-mounted	Surface-mounted	N/A	Surface-mounted
Minimum connection cross-section	3 x 8,4 mm ²	3 x 8,4 mm ²	6 AWG	3 x 8,4 mm ²	6 AWG

Part number	61 90 5 A1E 1B1	61 90 5 A1E 1B2	61 90 5 A1E 1B3	61 90 5 A1E 1B4	61 90 5 A1E 1B5
Internal fault current detection	Alternating current: 15~30 mA Direct current: 3~6 mA	Alternating current: 15~30 mA Direct current: 3~6 mA	Alternating current: 20 mA	Alternating current: 15~30 mA Direct current: 3~6 mA	Alternating current: 20 mA
Protection against electric shock	Class II				
Housing ingress protection (for indoors and outdoors)	IP65	IP65	NEMA 3S	IP65	IP65
Dimensions (W x H x D)	270x370x185 mm				
Weight	6 kg	6 kg	8 kg	6 kg	6 kg
Electrical protection from	Overcurrent, short-circuit, overvoltage, undervoltage, earth faults, excess temperature.				

Interfaces	
Display	LED
Communication	Bluetooth
Ambient conditions	
Operating temperature	-40 °C ~ +50 °C
Temperature properties	This is not a safety device, it is only a function. The specified operating temperature range must not be exceeded. The device supplies the charging current continuously within the specified operating temperature ranges. To increase the charging availability, the charging current is reduced from 32 A to 24 A, 16 A and 6 A if the temperature is exceeded. After this, the charging cycle may also be shut down. Once the temperature has dropped, the charging cycle is continued and the charging current is adjusted to the configuration.
Storage temperature	-40 °C to +80 °C
Humidity	95 % relative humidity, non-condensing
Height	3,000 m
Cooling	Natural cooling
Impact protection	IK09
Overvoltage category	OVC III
Action after a power outage	Random delay between 5 and 100 seconds before the charging cycle is restarted after a power outage

Note: The available charging capacity depends on the vehicle, infrastructure and general settings.

13 Waste disposal

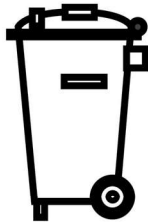
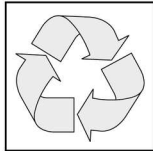

After it has been decommissioned correctly, have the device disposed of by the Service Department in compliance with current waste disposal regulations.

Electrical and electronic devices and the accessories must be disposed of separately from general household waste. Information about this is provided on the product, in the instructions for use or on the packaging.

The materials may be recycled as shown by the symbols. You can make a major contribution to protecting our environment by reusing, recycling the material or other forms of recycling end-of-life devices.